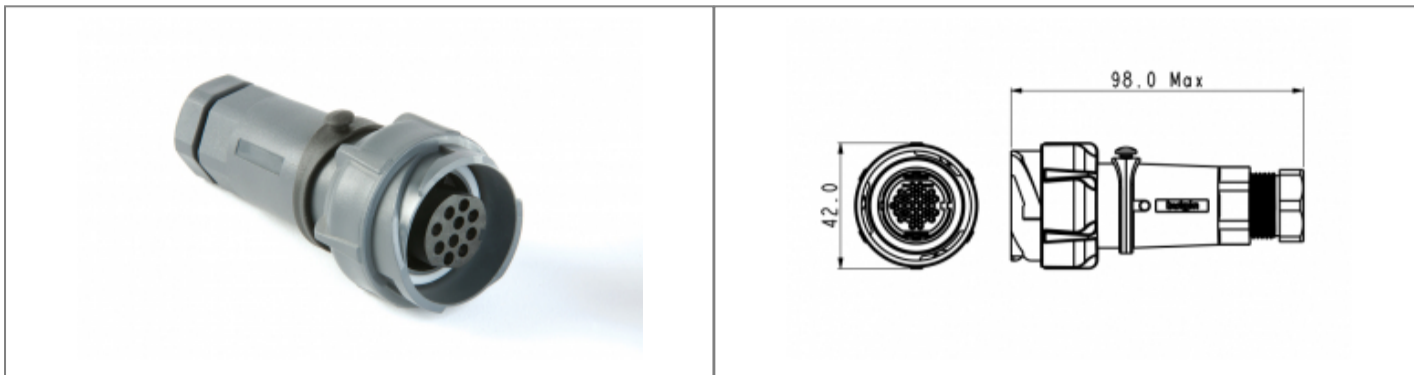

PXP7011/32P/CR/1113 Datasheet

**Product Name // Inline Cable Connector PXP7011 Series
32 Contact Plug Crimp/Solder Termination (contacts
available separately) 11mm-13mm Cable (Yellow Gland)
Plastic Body**

[View Product Page](#)

// Product Description:

- ⊕ Inline Cable Connectors
- ⊕ Water and dustproof to IP66, IP68, IP69K when mated with compatible connector
- ⊕ Quick turn locking ring with less than quarter turn locking and positive feedback
- ⊕ Plug or Socket
- ⊕ 2, 3, 6, 10, 32 Contact with leading Earth contact on 3 Contact versions
- ⊕ Screw, Crimp/Solder terminations available, depending on part code; Screw contacts supplied fitted, Crimp/Solder contacts and fitting tools available separately
- ⊕ Choice of body material depending on part code:
- ⊕ Plastic body (part codes prefixed PXP)
- ⊕ Metal body (part codes prefixed PXM). Cable Braid Termination option supplied with part codes suffixed /SN or available separately (part code PXM7090)
- ⊕ Choice of cable acceptance 5mm-15mm diameter depending on part code (see data for details)
- ⊕ PXP7088 Series Gland Packs available separately to accommodate all sizes
- ⊕ PXP7082/PXM7082 Sealing Cap available separately to maintain IP rating of unmated connectors
- ⊕ Mate with PXP7010/PXM7010 Series Flex Connectors

// General Information:

Product Display Title:	Inline Cable Connectors
Product Family:	Circular Power Connectors
Product Series:	7000 Series Buccaneer
Approvals:	UL
Body Material:	Polycarbonate/Polybutylene Terephthalate (PC/PBT)
Body Material Type:	Plastic Body
Contact Type:	Plug Contact
Coupling Type:	Bayonet Lock
Current Max:	3A
Diameter Over Coupling Ring Mm:	42mm
Flamability Rating:	UL94V-0
Function:	Inline Cable Connector
Ip Rating:	IP66
Max Cable Entry Size:	13mm
Min Cable Entry Size:	11mm
Max Contact Accomodation Awg:	26AWG
Min Contact Accomodation Awg:	22AWG
Max Contact Accomodation Mm2:	0.34mm ²
Min Contact Accomodation Mm2:	0.14mm ²
Max Operating Temperature:	+120°C
Min Operating Temperature:	-40°C
Number Of Contacts:	32 Contacts
Voltage Max:	600V

// Product PDF Links

[7000 Series power connectors...](#)
[7000 Series plastic body power...](#)

// Product 3D CAD Model Links

[PXP7011/32P/CR/11133D CAD Model](#)

Have a question or project enquiry
you'd like to talk to us about?



[Click Here To Contact Us](#)