

# PXP7010/03S/ST/0507 Datasheet

**Product Name // Flex Cable Connector PXP7010 Series 3**  
**Contact Socket Screw Termination (contacts supplied fitted) 5mm-7mm Cable (Grey Gland) Plastic Body**

[View Product Page](#)

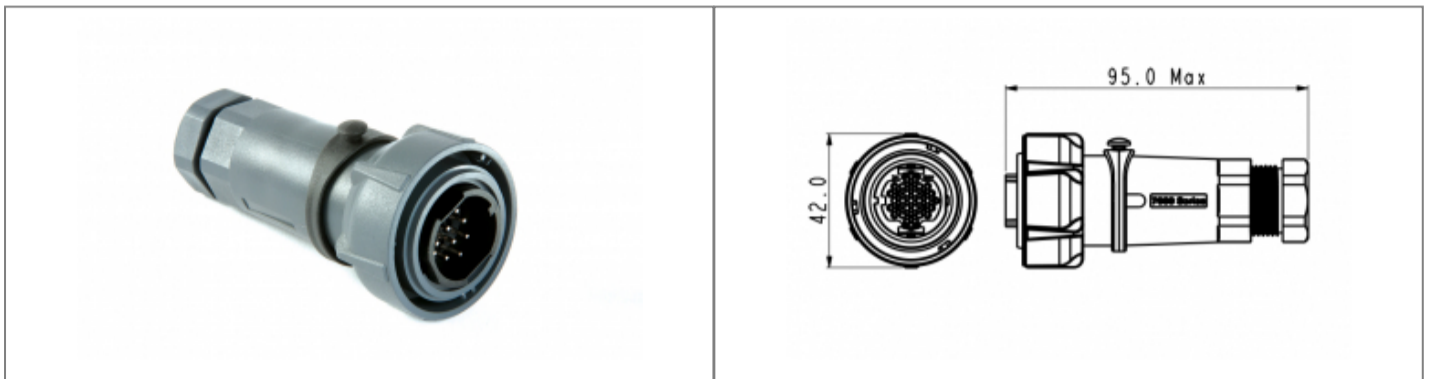

## // Product Description:

- ⊞ Flex Cable Connectors
- ⊞ Water and dustproof to IP66, IP68, IP69K when mated with compatible connector
- ⊞ Quick turn locking ring with less than quarter turn locking and positive feedback
- ⊞ Plug or Socket
- ⊞ 2, 3, 6, 10, 32 Contact with leading Earth contact on 3 Contact versions
- ⊞ Screw, Crimp/Solder terminations available, depending on part code; Screw contacts supplied fitted, Crimp/Solder contacts and fitting tools available separately
- ⊞ Choice of body material depending on part code:
- ⊞ Plastic body (part codes prefixed PXP)
- ⊞ Metal body (part codes prefixed PXM). Cable Braid Termination option supplied with part codes suffixed /SN or available separately (part code PXM7090)
- ⊞ Choice of cable acceptance 5mm-15mm diameter depending on part code (see data for details)
- ⊞ PXP7088 Series Gland Packs available separately to accommodate all sizes
- ⊞ PXP7081/PXM7081 Sealing Cap available separately to maintain IP rating of unmated connectors
- ⊞ Mate with PXP7011/PXM7011 Series Inline and PXP7012/PXM7012 Series Front Panel Mount Connectors

## // General Information:

Product Display Title:	Flex Cable Connectors
Product Family:	Circular Power Connectors
Product Series:	7000 Series Buccaneer
Approvals:	UL
Body Material:	Polycarbonate/Polybutylene Terephthalate (PC/PBT)
Body Material Type:	Plastic Body
Contact Type:	Socket Contact
Coupling Type:	Bayonet Lock
Current Max:	25A
Diameter Over Coupling Ring Mm:	42mm
Flamability Rating:	UL94V-0
Function:	Flex Cable Connector
Ip Rating:	IP66
Max Cable Entry Size:	7mm
Min Cable Entry Size:	5mm
Max Contact Accomodation Awg:	10AWG
Min Contact Accomodation Awg:	10AWG
Max Contact Accomodation Mm2:	6mm <sup>2</sup>
Min Contact Accomodation Mm2:	6mm <sup>2</sup>
Max Operating Temperature:	+120°C
Min Operating Temperature:	-40°C
Number Of Contacts:	3 Contacts
Voltage Max:	600V

### // Product PDF Links

[7000 Series power connectors...](#)

[7000 Series plastic body power...](#)

### // Product 3D CAD Model Links

[PXP7010/03S/ST/05073D CAD Model](#)