

PXMBNI78FPF05AFLPG135005 Datasheet

**Product Name // 5 Contacts 7/8" Front Panel Mounting
Female 500mm Flying Leads**

[View Product Page](#)

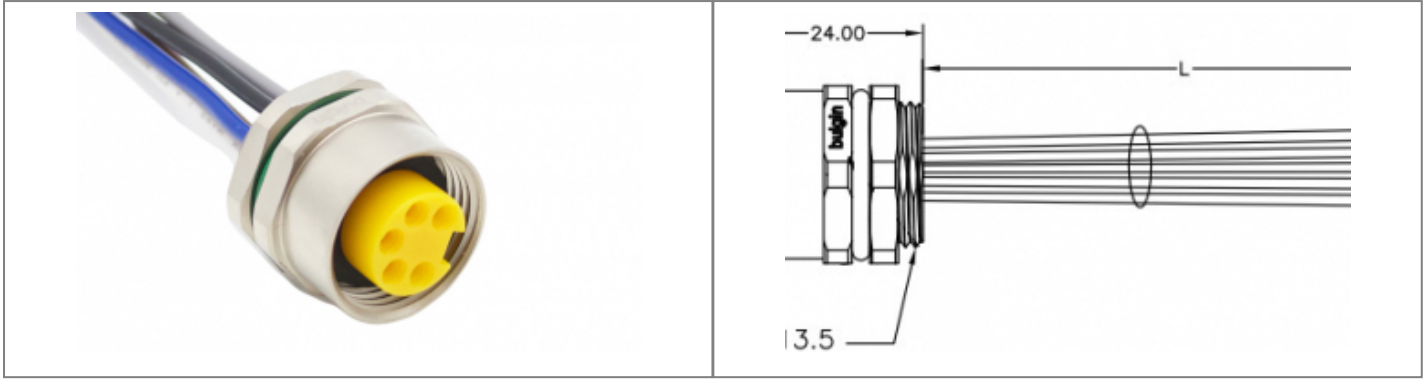

// Product Description:

- ⊞ 3 Contacts 7-8" Front Panel Mounting Female 0.5M Cable
- ⊞ IP67 rated when mated
- ⊞ Mechanical Cycles >100
- ⊞ Operating Temperature -25°C to +85°C
- ⊞ Rated Voltage 300 V
- ⊞ ROHS compliance

// General Information:

<p>Product Display Title:</p> <p>Product Family:</p> <p>Product Series:</p> <p>Cable Length:</p> <p>Connection Method:</p> <p>Contact Type:</p> <p>Current Max:</p> <p>Durability:</p> <p>Function:</p> <p>Insulation Resistance:</p> <p>Ip Rating:</p> <p>Max Operating Temperature:</p> <p>Min Operating Temperature:</p> <p>Number Of Contacts:</p> <p>Pin Layout Code:</p> <p>Rohs Compliant:</p> <p>Thread Size:</p> <p>Voltage Max:</p>	<p>7/8" Front Panel Mounting Female 500mm Flying Leads</p> <p>Circular Automation Connectors</p> <p>7/8" Series</p> <p>0.5m</p> <p>Solder</p> <p>Socket Contact</p> <p>9A</p> <p>>100 Cycles</p> <p>Front Panel Mounting Female Connector with Flying Leads</p> <p>>100MOhm</p> <p>IP67</p> <p>+80°C</p> <p>-25°C</p> <p>5 Contacts</p> <p>A Code</p> <p>Yes</p> <p>PG13.5</p> <p>300V</p>
---	--

// Product PDF Links

[78 Series Circular connectors...](#)

// Product 3D CAD Model Links

[PXMBNI78FPF05AFLPG1350053D CAD...](#)