

PX0407 Datasheet

Product Name // Straight SMB Antenna 2.4GHz-2.5GHz

[View Product Page](#)

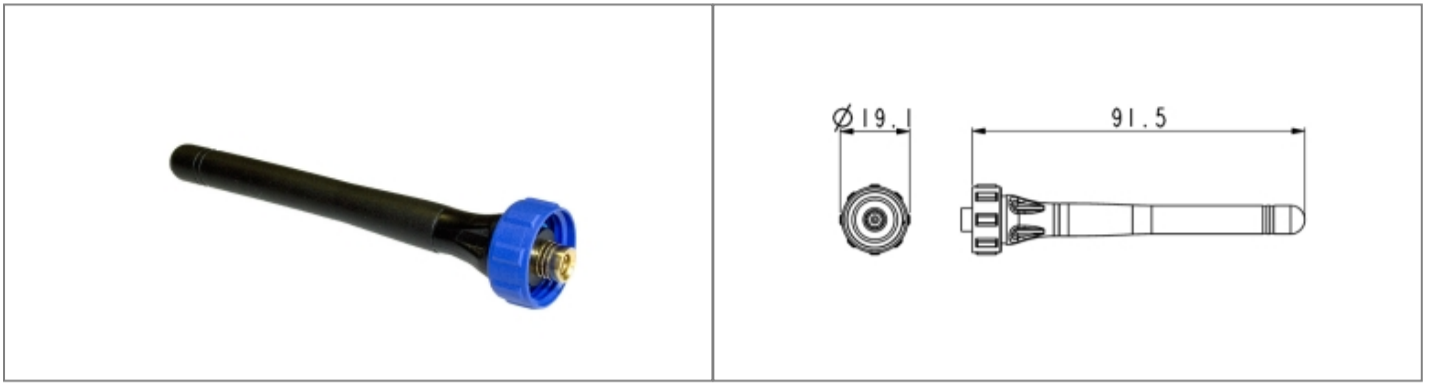

// Product Description:

- ⊕ SMB Antennas
- ⊕ Water and dustproof to IP68 when mated with compatible connector
- ⊕ Secure screw thread locking
- ⊕ Built-in half wavelength omnidirectional sealed antenna
- ⊕ Choice of two presentations depending on part code:
- ⊕ 90 degree bend (part codes suffixed /90)
- ⊕ Straight (no part code suffix)
- ⊕ SMB 50 Ohm interface
- ⊕ Choice of frequency bands depending on part code:
- ⊕ PX0407, PX407/90 - 2.4Ghz-2.5GHz
- ⊕ PX0408, PX408/90 - 440MHz-470MHz
- ⊕ PX0409, PX409/90 - 850-900Mhz/1800Mhz/1900MHz
- ⊕ Mate with PX0414 Panel Mount SMB Connector

// General Information:

Product Display Title:	SMB Antennas
Product Family:	Circular Data Connectors
Product Series:	400 Series - Wireless Buccaneer
Body Material:	PVC
Body Material Type:	Plastic Body
Contact Type:	Plug Contact
Coupling Type:	Screw
Diameter Over Coupling Ring Mm:	19.1mm
Flamability Rating:	UL94V-0
Function:	Antenna
Ip Rating:	IP68, IP69K
Max Operating Temperature:	+80°C
Min Operating Temperature:	-40°C
Number Of Contacts:	1 Contact

// Product PDF Links

[400 Series SMB connectors product...](#)

// Product 3D CAD Model Links

[PX04073D CAD Model](#)